

# 5GDN Industry White Paper



# Contents

<b>Industry Digital Transformation Is Accelerating</b>	<b>01</b>
1. The 5G Customer Market is Growing Rapidly, and Trillion-scale Industry Digital Transformation Is Coming Soon	01
2. "3+4+X" Application System for 5G-enabled Industry Digital Transformation	03
3. Industry 5G Digital Transformation Requires Differentiated, Dedicated, and Customizable 3D Network Services	05
<b>5GDN Definition and Implementation Factors</b>	<b>07</b>
1. Building a CORE-based 5GDN	07
2. 3GPP Release Progress of 5GDN	09
3. Four-Step Planning and Deployment of 5GDN	11
<b>Global Applications</b>	<b>12</b>
1. 5GDN@Smart Port	11
2. 5GDN@Smart Grid	14
3. 5GDN@Smart Manufacturing	16
4. 5GDN@AR/VR	18
<b>Summary</b>	<b>20</b>
<b>Acronyms and Abbreviations</b>	<b>21</b>

# Industry Digital Transformation Is Accelerating

## 1 The 5G Customer Market is Growing Rapidly, and Trillion-scale Industry Digital Transformation Is Coming Soon

2019 witnessed the start of the rollout of 5G as the year progressed. 5G networks and services were deployed faster than expected. 348 global operators have invested in 5G networks, of which 61 have commercially launched 5G services, such as augmented reality, virtual reality and fixed wireless access. In the 5G era, consumers will enjoy better experience, and benefit from a new wave of the application innovation . Not only will the 5G network enrich our lives, but it will also become a platform for innovation, bringing an array of opportunities to industry.

A study by Keystone Strategy & Huawei SPO Lab reports that investment in industry digital transformation is increasing steadily year by year. It is estimated that by 2025, the digital revenue of global ICT vendors will reach approximately US\$ 4.7 trillion. The 10 industries researched in this study were: manufactory/supply chain, smart city, energy/utilities, AR/VR, smart home, eHealth, smart agriculture, intelligent retail, automotive, and drones/autonomous vehicles. The 5G market is expected to be worth US\$ 1.6 trillion or more, of which US\$ 840 billion (over 50%) will be shared between mobile operators.

By leveraging advanced communication technologies, operators can play new roles and assume greater responsibility in the 5G industry value chain. They can provide infrastructure, digital platforms, and services specific to industry applications. By 2025, the market value of 5G consumer services will increase moderately to US\$ 238 billion, but over the same period the value of 5G industry digital transformation will exceed US\$ 600 billion. The same forecast shows the market value of 5G connectivity applications will reach US\$ 232 billion, and the market value of 5G non-connectivity applications will reach US\$ 370 billion.

4.7 Trillion ICT investment expected in 2025,  
up to 18 percent of the 5G market addressable by telco operator(US \$, Billion)

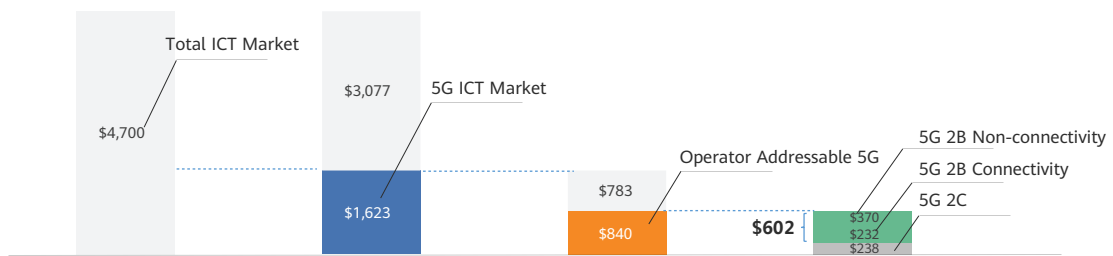

Source: Keystone Strategy & Huawei SPO Lab

Figure 1 - Global ICT Investment Forecast for Year 2025

Differently from the consumer market, telco partners can participate more in the industry value chain depending on their capabilities.. In the unmanned aircraft system (UAS) industry, connectivity services which are the foundation for innovation that account for 11% of the market value. However, connectivity-supported platforms and services, such as data collection, data management, secure storage, and analytical services, account for a much greater 53% of the market.

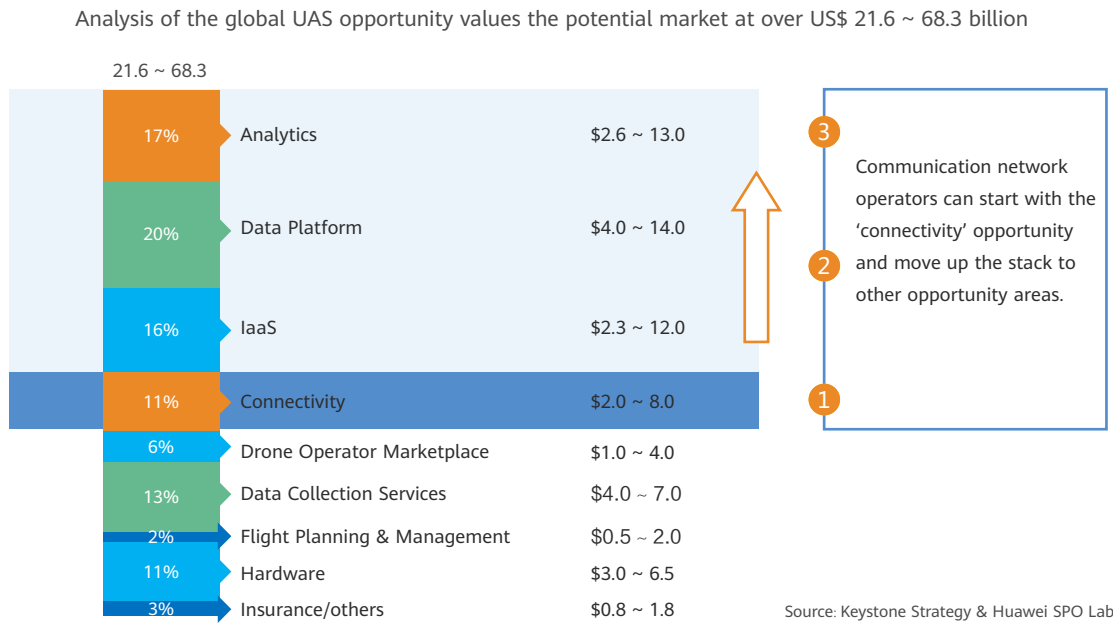

Figure 2 – Market Value Chain Analysis of Unmanned Aircraft Systems

Operators can participate in the value chain at different levels depending on their capabilities.

- ◆ Traditional operators who provide non-differentiated connectivity could capture 11% of the market opportunity.
- ◆ "Smart pipe" operators who provide differentiated connectivity and specific digital products and services could capture 14% to 27% of the market opportunity.
- ◆ Integrated service providers who provide comprehensive infrastructures, network connectivity, and digital services could capture 23% to 34% of the market opportunity.

	Flight Planning & Management	Data Collection Services	Connectivity	IaaS	Data Platform	Analytics
Traditional Pipes	○	○	√	×	×	×
'Smart Pipes'	√	√	√	○	√	○
Integrated Service Providers	√	√	√	√	√	√

○: Optional

Source: KeyStone Strategy & Huawei SPO Lab & CAICT

Figure 3 – Value Chain Opportunity of Operators in Different Roles

According to a survey by Huawei SPO Lab, both the return on investment (15%) and operating profit margin (16.4%) of "smart pipe" operators are higher than the industry averages of 12.7% and 15.6%.

## 2 "3+4+X" Application System for 5G-enabled Industry Digital Transformation

5G is spreading across industries and has become an important tool for industry digital transformation. Chinese operators and their industry partners lead the vanguard. In 2019, the second "Zhanfang Cup" a 5G innovation contest was held under the guidance of China's Ministry of Industry and Information Technology (MIIT). A total of 3731 projects participated in the contest, derived from more than 10 industries. They covered three scenarios : smart life, digital governance, and industry digitalization. Smart life applications bring immersive experiences and new innovations to life and work. Digital governance applications focus on improving urban governance capabilities and efficiency. Industry digitalization applications utilize 5G in industries to drive digital transformation and develop new enterprise opportunities.

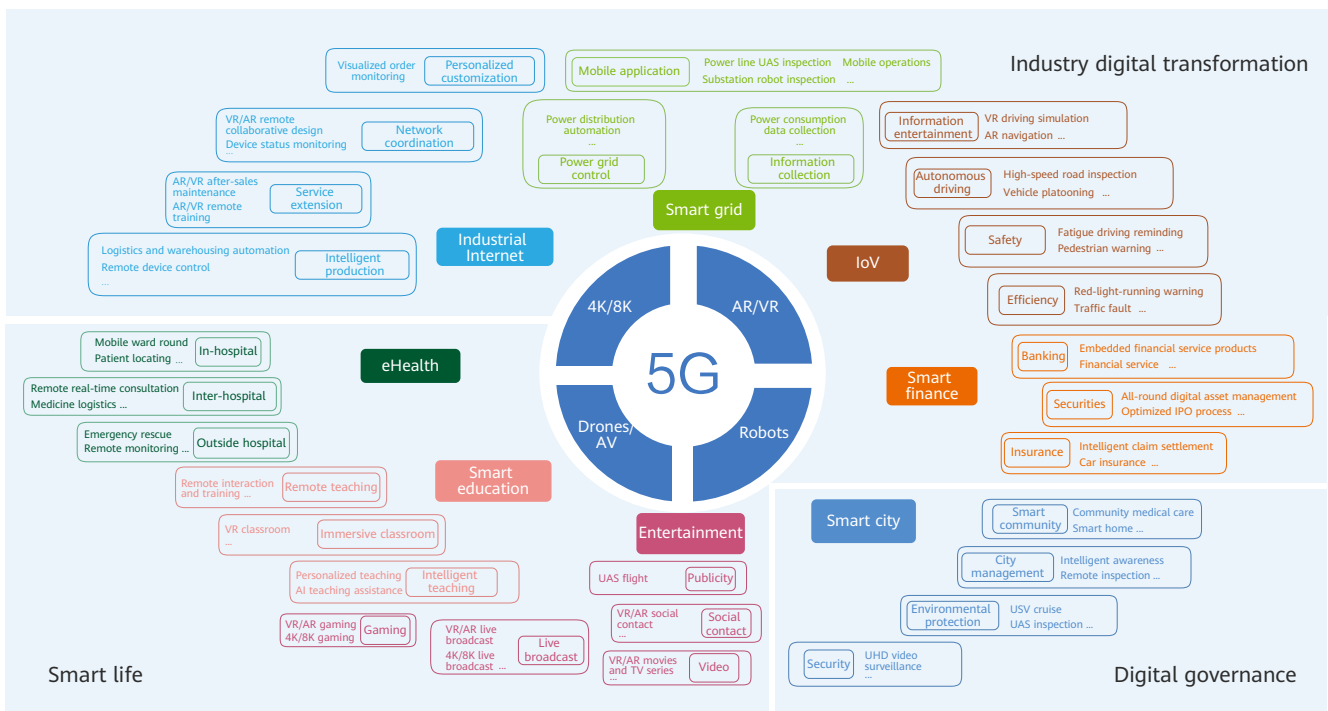

Source: CAICT

Figure 4 - Three Categories of Innovative 5G Applications in "Zhanfang Cup" Contest

The 5G industry are now focusing on "4+X" requirements for applications (4 general-purpose technologies and multiple derived innovative applications).

<sup>2</sup> White Paper on the 5G Application Innovation – Insights into the Second "Zhanfang" Cup 5G Application Contest, CAICT, Oct 2019

5G is expected to provide industries with high bandwidth/low latency connectivity, cope with harsh/outdoor environments, offer mobility, and fast deployment. Technologies such as 4K/8K ultra-high-definition (UHD) videos, VR/AR, robots, and UAS/USV/unmanned vehicles are penetrating all industries. Some of the applications these technologies are listed below:

5G is expected to provide industries with high bandwidth/low latency connectivity, cope with harsh/outdoor environments, offer mobility, and fast deployment. Technologies such as 4K/8K ultra-high-definition (UHD) videos, VR/AR, robots, and UAS/USV/unmanned vehicles are penetrating all industries. Some of the applications these technologies are listed below:

- ◆ 4K/8K UHD videos are used for entertainment and surveillance.
- ◆ Robots on automated guided vehicles (AGVs).
- ◆ Remote control technologies on r UAS/USV/unmanned vehicles.

Each general-purpose technology can produce multiple innovative industry applications. For example, UASs have applications in logistics, pesticide spraying, land survey, laser mapping, and live video backhaul. Furthermore, multiple technologies can be used for in one industry. A smart port can deploy intelligent monitoring within port campus. It can use VR for device maintenance, remote operations technology to control tires cranes, and automated guided vehicles to improve container transportation efficiency. Operators and partners can boost innovation investment and accelerate 5G innovation in industry, by promoting its use in existing mature business applications.

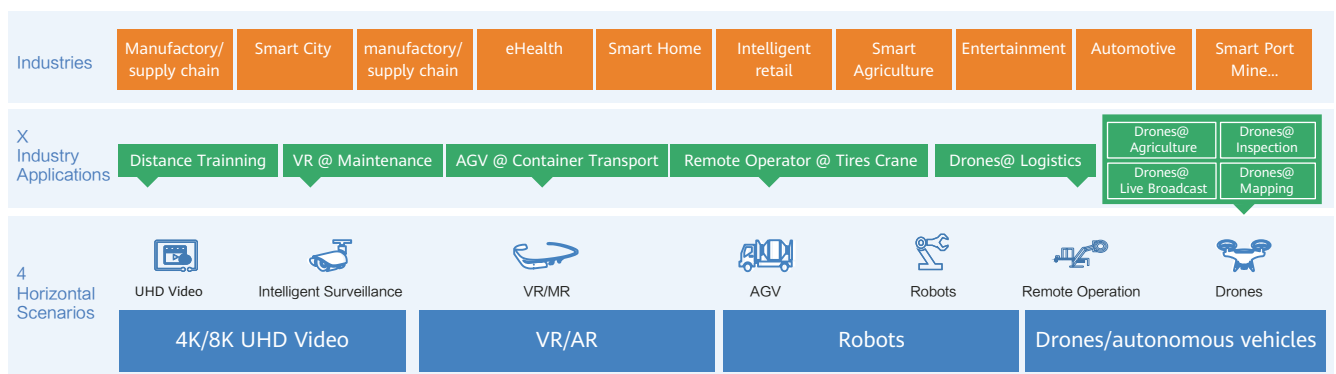

Source: CAICT

Figure 5 - 4+X Industry Application Scenarios

5G is being applied to fields including manufactory, eHealth, education, ports, and electric power, generating a wide range of innovative applications. 5G is now fueling digital transformation in many industries and what is more its scope of use is becoming wider and deeper.

Based on the Huawei CLab & SPO Lab survey of 10 global industries, 5G, as a platform technology, brings the huge potential for industry digital transformation. The percentage share for connectivity services in each industry ranges from 10% to 24%. Industries such as smart city, energy, utilities, automobiles, manufactory, and supply chains purchase a

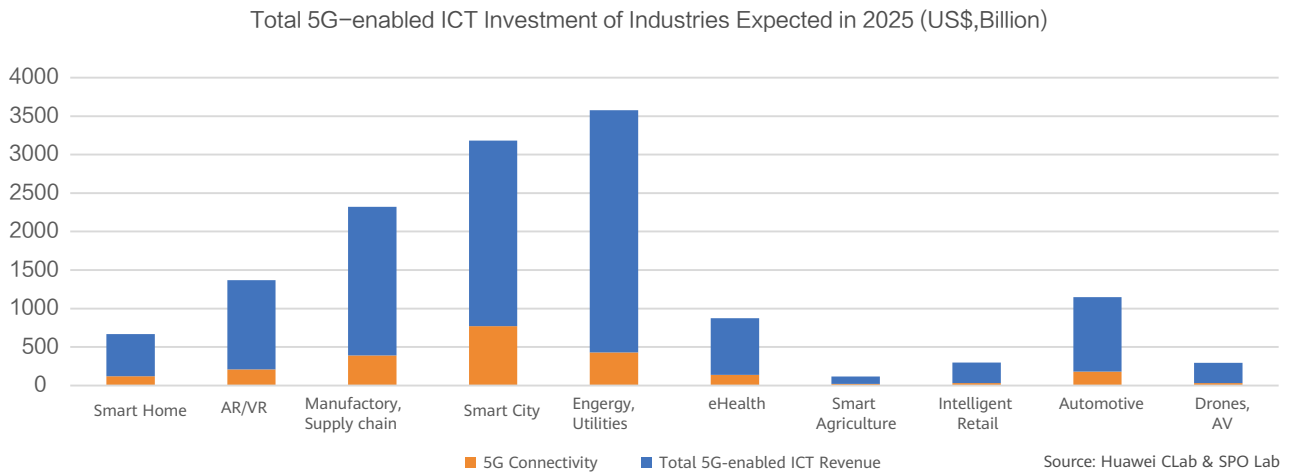

Figure 6 – 5G Enabled Industry ICT Investment Forecast by 2025

### 3 Industry 5G Digital Transformation Requires Differentiated, Dedicated, and Customizable 3D Network Services

An analysis of more than 100 applications in more than 10 industries showed that the requirements of industry digital transformation using 5G networks can be divided into three dimensions: differentiated networks with orchestratable capabilities, dedicated networks with guaranteed data security, and self-service (DIY) networks with automated management.

Differentiated networks are critical for industry digital transformation. Unlike the common requirements of mass consumers, industries have a diverse set of requirements. For example, remote metering requires massive network connection density over bandwidth and latency. Services such as telemedicine and autonomous driving depend on low latency (within a deterministic range), security, and reliability. The magnitude of these 5G capabilities can be hard to appreciate but as an example to reach a reliability rate of 99.9999%, an annual fault time of just several seconds is acceptable. Previous generations of mobile technologies focused on bandwidth but 5G revolutionizes industry by providing multi-dimensional network capabilities while guaranteeing experience.

Dedicated networks securely isolate data and protect data privacy, this is a common requirement of business globally. Network security, roles and domain-specific management, resource isolation, as well as data and signaling security are requirements of internet and smart grid applications. Campus-limited access to production data and user data is common requirement where demands dedicated virtual isolation network. ,.

Self-service (DIY) networks are an indispensable enabler for agile innovation in industry. Industry users need to customize, design, and tailor their networks to meet frequently changing service user requirements. For instance, a campus IoT service user needs to orchestrate, schedule, and manage IoT network service parameters to flexibly deploy networks and applications, as well as to add or delete devices.

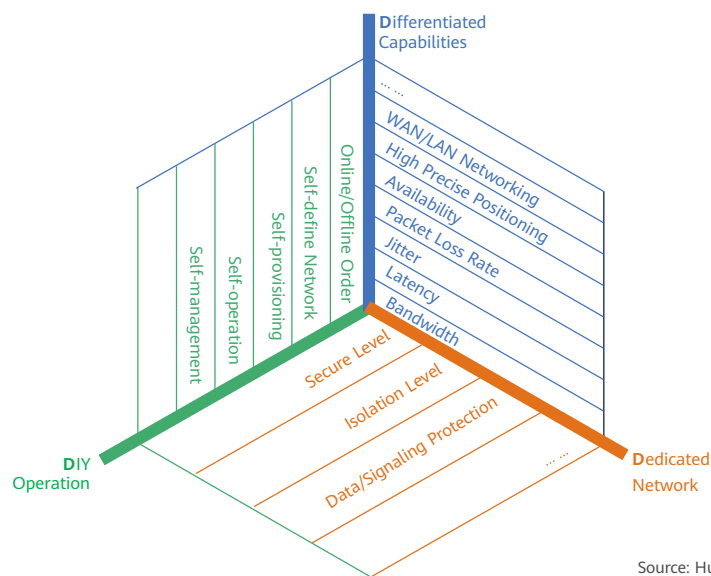

Figure 7 - 3D Dimensions of Network SLA for Industry Digital Transformation

The core asset for operators to promote digital transformation in industry is a 5G deterministic networking (5GDN) built based on the three dimensions listed above. The 5GDN, with its guaranteed SLAs would be applied not only for less-rigid SLA requirements market, but also most likely be reserved for market segments with the strictest requirements and the largest potential revenue (such as industrial automation).



# 5GDN Definition and Implementation Factors

5GDN leverages 5G network resources to build manageable, verifiable and deterministic virtual private mobile networks, offering customers a predictable and differentiated service experience.

## 1 Building a CORE-based 5GDN

Before 5G comes, the MBB network is a best-effort network while fixed network private lines have specific SLA requirements. Compared with individual or home packages with the same bandwidth, enterprise private lines require not only bandwidth guarantee, but also SLA guarantees in reliability, service availability, professional services, and more. In the Industrial Internet with stricter requirements, IEEE and IETF have defined the TSN standards and DetNet working group to study deterministic communication development in industrial automation, vehicle management, and other fields.

	Level 0	Level 1	Level 2	Level 3
Bandwidth	Best-effort	UL: 5 Mbit/s DL: 20 Mbit/s	UL: 15 Mbit/s DL: 60 Mbit/s	UL: 30 Mbit/s DL: 120 Mbit/s
Latency	Best-effort	30~50ms	15~30ms	<15ms
Service availability	Best-effort	99.9%	99.95%	99.99%
*Note: Regarding service availability, 99.9% means that services may be interrupted for 8 hours each year, 99.95% means that services may be interrupted for 4 hours each year, and 99.99% means that services may be interrupted for 1 hour each year.				

Figure 8 - Quality SLA levels for typical private lines

Mobile networks and fixed networks differ in SLA guarantees because a mobile communications network consists of the radio access network (RAN), transport network (TN), and core network (CN). The RAN is open and prone to interference, with scarce resources. As a result, some unpredictability leads to non-deterministic results. CN is key for network topology & resource scheduling, service orchestration & scheduling, and E2E service experience management. Further, the CN provides deterministic experience (including latency) of service applications and networks based on service awareness, helping the RAN improve deterministic capabilities. Therefore, the CN is considered as the real core of 5GDN, perhaps even of the entire 5G era. To address this, operators can plan and build a 5GDN based on the "CORE" factors.

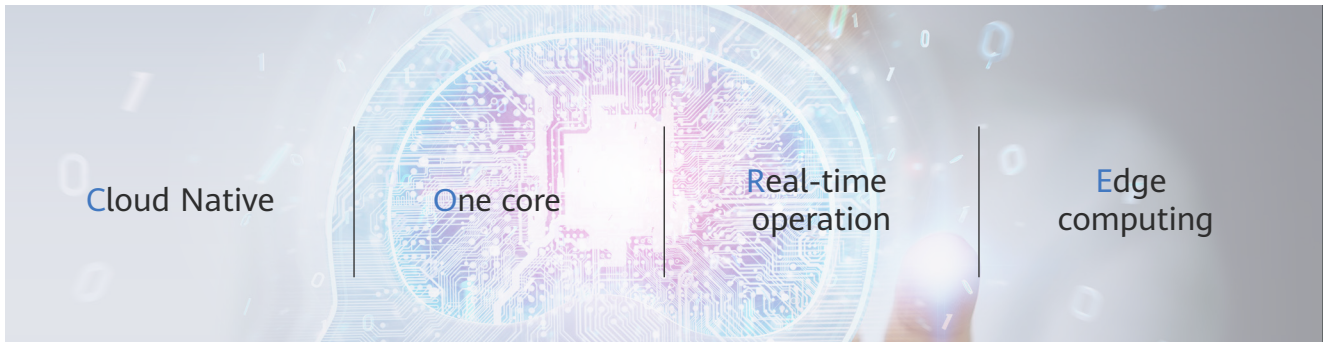

## Cloud Native

Cloud Native: Lays the foundation for all solutions. Different from the traditional private line market, the Cloud Native-based 5G mobile network can be transformed into a private network based on mobility and transformed into a virtual private line network based on cloud-based flexible resource orchestration. The microservice and container technologies provided by Cloud Native, make the entire network more reliable and flexible, and make service deployment more agile. For example, private line services require specific SLA guarantees in terms of reliability. On a traditional network, reliability mainly depends on exclusive use of hardware resources. On an all-cloud network, however, operators can define differentiated SLAs and dynamically adjust SLAs in multiple ways, such as host aggregate (HA) isolation, VDC or VPC isolation, network slice isolation, and resource sharing.

Cloud infrastructure is also an important part of 5GDN. The deployment environment of industry scenarios may be complex and has special requirements for function and performance. Traditional industry networks usually use dedicated hardware and protocol stacks. However, the dedicated solution is not universal and scalable, and the cost is high. Therefore, the cloud-based infrastructure is vital for 5GDN to satisfy different environment and to be shared by different applications.

## One core

5GDN must be an access agnostic core that supports all radio access technologies (RATs) since the existing 2G/3G/4G terminals and services are inevitably involved. In addition, some industry applications are highly dependent on voice and SMS services. Therefore, one voice network and efficient voice codec capability are also crucial.

## Real-time operation

Dynamic network slicing is implemented on 5GDN, requiring full automation in network deployment, provisioning, O&M, and other processes. The work order-based processing on traditional networks cannot accommodate the efficient development of industry services. Therefore, the portal mode can be used so that industry users autonomously handle the processing. Each industry user customizes and purchases required slices from the online store, and then manages the slice network through one-click provisioning and remote monitoring and O&M. For example, to stream live events, media companies do not need to connect cables on site in advance, but purchase slice resources for a specific time and area on the operator's portal website. Media companies can then conduct interviews and shoot videos on site, and efficiently transmit video images to the broadcasting system through the 5G network.

## Edge computing

5GDN uses MEC to deliver differentiated connectivity and SLA guarantee for enterprises and industries. Due to the high-performance connectivity provided by MEC, operators can further combine connectivity with applications to fit service requirements and SLA requirements of different industries. For example, operators can provide the "connectivity + video rendering" capability for media livestreaming, the "connectivity + machine vision" capability for manufacturing, and the "connectivity + fleet management" capability for smart transportation.

3GPP specifications provide basic deterministic capabilities, and its progress along with operator network planning must be considered to implement CORE-based architecture and functions. The pace of operator network planning and solutions are key and need to be promoted step by step based on given scenarios, and build 5GDN flexible and agile capabilities.

## 2

### 3GPP Release Progress of 5GDN

Before defining 5G, 3GPP has analyzed the 5G requirements of related industries. Several key technologies and services are introduced to supplement the 5GS reference architecture, and explicitly support time sensitive communications (TSC) to provide deterministic communication capabilities in 3GPP R16.

R15	R16	R17
Supports eMBB. Supports basic functions to provide low latency and high bandwidth.	Supports typical 2B scenarios. Supports deterministic	Further expands 2B scenarios supported by deterministic communication and exposes deterministic communication capabilities of 5G networks to vertical industries.

Figure 9 - Definitions of deterministic functions in 3GPP specifications

In terms of architecture, 5G provides network slicing (defined in 3GPP R15 and implemented in 3GPP R16) to slice a mobile network into different virtual networks, and provides slice services with differentiated SLAs and security isolation between network slices. A network slice logically consists of the RAN, TN, and CN, and is managed by the network slice management function (NSMF) from end to end. Considering the differences in difficulties and necessity of slice implementation on the three networks, the network slice subnet management function (NSSMF) on each network can also be responsible for designing the network slice. The CN is a service interaction concentrator, where a network slice should be deployed preferentially. In addition, MEC (defined in 3GPP R15) deployed close to services further ensures the availability of low latency on each slice.

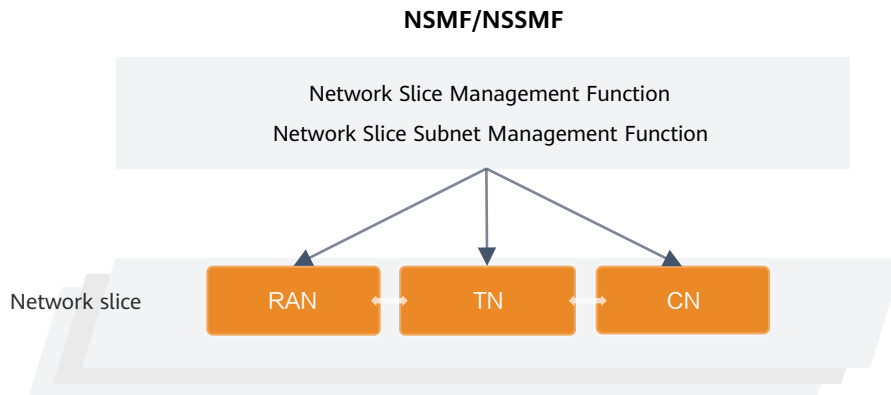

Figure 10 - Architecture of a network slice

3GPP also defines and enhances deterministic communication functions in R15, R16, and the upcoming R17. In R15, 3GPP uses 5G 5QI as the basic framework. With smaller scheduling units and periods over the air interface, URLLC high-priority preemption, uplink scheduling-free, and other key technologies, 3GPP provides basic support for E2E low latency and high bandwidth. In R16, 3GPP utilizes the redundant transmission feature provided by URLLC to ensure reliable E2E transmission. In addition, 3GPP introduces the TSN mechanism to further assure the latency, jitter, and reliability. In this way, deterministic communication services can be provided for typical scenarios such as industrial control. In R17, 3GPP continues to introduce the UE-UE deterministic capability through IIoT to cover a wider range of applications in 2B scenarios such as smart grids, and to expose 5G deterministic capabilities to vertical industries.

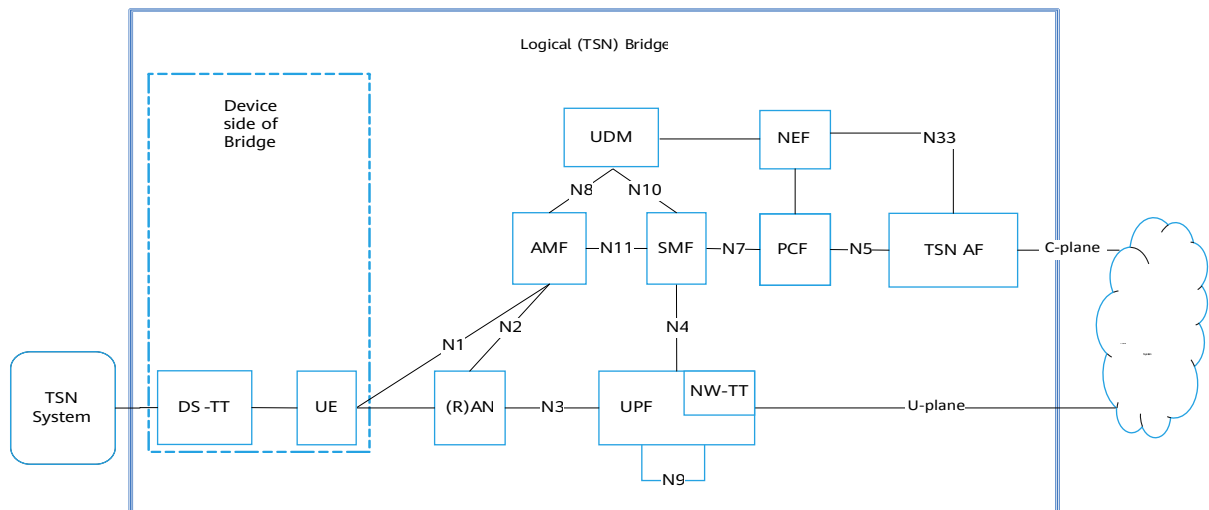

Figure 11 - Support for TSN in 5G

For enterprise networks or Industrial Ethernet Internet, 3GPP R16 introduces the support for 5G-LAN in 5GS, greatly enhancing the practicability of 5G in enterprises and industries.

The deterministic capability provided by 3GPP-defined functions is basic and static. It is only used to support certain SLA

combinations required in specific scenarios. Therefore, the network deployment planning from operators and mature commercial product solutions are important to effectively deliver differentiated SLAs, support dynamic service adjustment, and cope with potential emergencies with limited resource availability. Furthermore, it is important to satisfy different security and management requirements in 5GDN even though the same performance SLA and service functions are required.

### 3 Four-Step Planning and Deployment of 5GDN

5GDN cannot be deployed at one stroke. Global operators' 5G deployment is still at an early stage, and is not mature enough to support the wide deployment of 5GDN. Therefore, operators need to select appropriate industries and scenarios, and keep up with the pace of network planning to explore opportunities for the early deployment of 5GDN.

Due to the lack of complete 5G basic network coverage, MEC can be used to preferentially deploy 5GDNs in the independent areas, such as enterprise campuses and harbors.

In terms of application scenarios, 5GDN should be deployed in industries where 3GPP specifications are relatively mature and operators' strong network connectivity is mostly required, for example, entertainment videos and media livestreaming. Machine vision, which is highly integrated with video in industrial scenarios, is also suitable for early deployments of 5GDN.

Industries can also choose their 5GDN deployment paces. Some industries with high SLA deterministic requirements can preferentially deploy 5GDN. For example, the power grid industry is in urgent need of digital transformation. The scenarios of power grid networks naturally require high isolation and support for deterministic latency. Therefore, it is also a preferential target for 5GDN deployment.

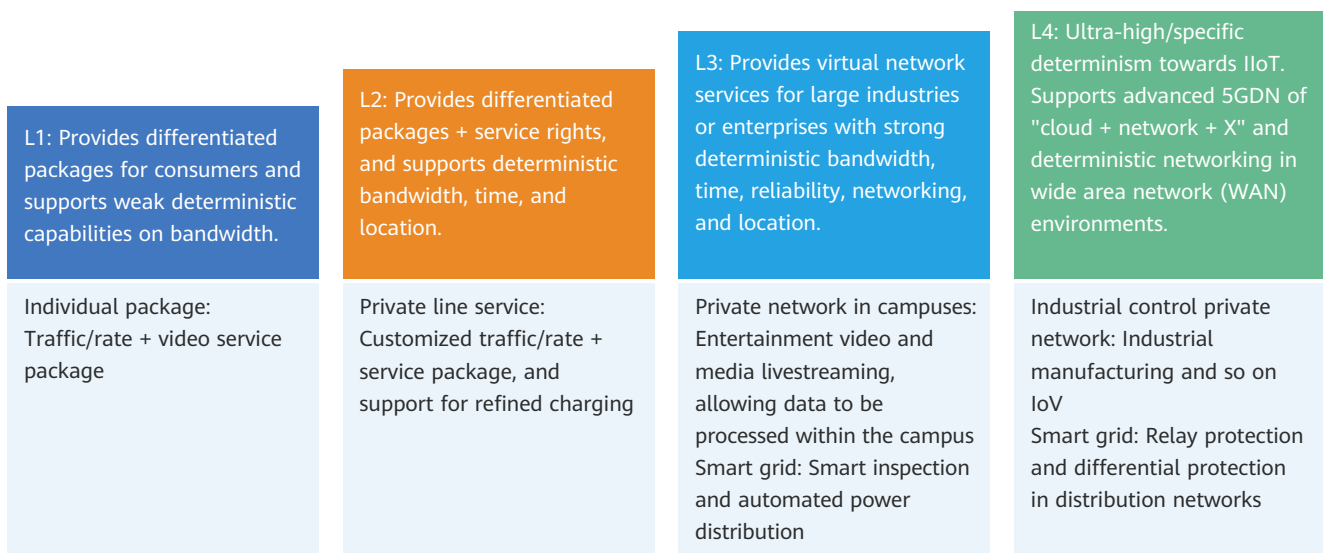

# Global Applications

In 2019, 5GDN has been piloted in many regions around the world. Especially in the Chinese market, operators, industry vendors, and telecom equipment providers have conducted in-depth cooperation research in many fields and achieved remarkable results. These achievements demonstrate the feasibility and business value of 5GDN applications in some industries. Following describes the applications of 5GDN in smart port, smart grid, smart manufacturing, and AR/VR.

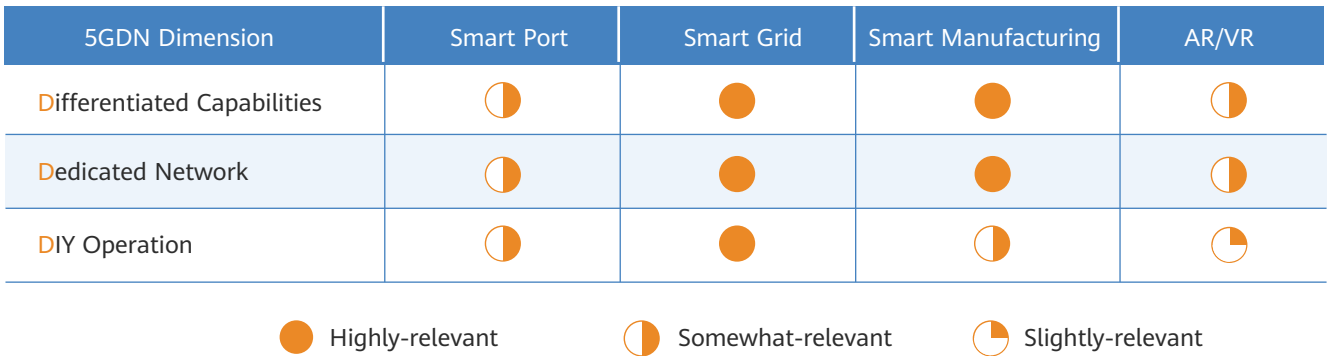

Figure 12 - 5GDN relevance to typical industries

## 1 5GDN@Smart Port

Ports are hubs for transporting cargo between container ships and vehicles. Seaborne trade contributes to two thirds of all global trade. There are more than 800 seaports in the world, among which seven of top-10 ports are in China, ranking No. 1 in the world. It is estimated that by 2025, the 5G communications service space in global ports will reach a worth of US\$2.4 billion annually. This could reach US\$700 million in China.

Let's look at remote control of RTG (rubber tyred gantry) cranes at ports where transformation is urgently needed. As a key service of port operation, the remote control has strict requirements on communication and control networks. The traditional port network solution has some limitations. Industry-oriented, dedicated, differentiated, and user-defined 5G

1. Workers remotely control RTG cranes based on multiple-channel video images backhauled to the control center. Differentiated networks are required to provide high uplink bandwidth (currently 35 Mbit/s for a single RTG crane, requiring optimization in future) and stable low latency.
2. RTG crane operation data is the key for ports. A dedicated network is required to isolate and locally process data.
3. The port communication and control network currently has problems such as slow commissioning and provisioning and an untraceable network running status. A DIY network is required to respond to rapidly changing

service requirements and make network monitoring more convenient.

To sum up, the primary scenario for 5GDN applications in smart port is remote control. Other scenarios include IGTV communication, video surveillance, and robot/UAS-assisted inspection. Operators need to use new deployment and service architectures when deploying networks to meet port owners' strict requirements. This will gradually realize the value of CORE-based networks and safeguard digital transformation of ports. Operators deploy the Cloud Native-based 5G mobile networks to allocate dedicated resources and allow for customized SLAs for control signal. Operators also deploy MEC at the network edge to fit PLC stability requirements of control signal latency. These deployments will make remote control of RTG cranes ready for commercialization and help port owners locally process data.

### Cases

- ◆ China Mobile, ZPMC, and Huawei worked together to implement a 5G smart port demonstration project in Yangshan Port. In 2019, the first-batch reliability verification of remote control on RTG cranes was initiated. By deploying 5G+MEC, HD video backhaul and remote control are implemented for RTG cranes, while meeting the port's requirements for data processing security. After remote control is implemented, the ratio of workers to RTG cranes is changed from 1:1 to 1:4, which could greatly improve the working environment and reduce the overall labor cost by up to 70%.
- ◆ China Mobile, ZPMC, and Huawei also worked together to implement 5G remote control of RTG cranes in Ningbo Port. The MEC deployment further reduced the average control signal latency from 28 ms to 10 ms.
- ◆ Huawei has applied the solution to the overseas market and verified the feasibility of 5G+MEC-based remote control of RTG cranes at the Laem Chabang Port in Thailand.



After the reconstruction into automation, one worker can remotely monitor multiple RTG cranes at the same time. This greatly improves the working environment for employees, reduces the labor cost of port enterprises, and resolves recruitment difficulties. ZPMC once tried to use Wi-Fi and 4G to build port communications infrastructure. However, these solutions could not meet the requirements of large bandwidth, low latency, wide coverage, and mobility. 5G makes all this possible.

-Shan Lei, General Manager of the technical R&D center of ZPMC





## 2

## 5GDN@Smart Grid

Thomas Edison gave the first public demonstration of electric light when he lit up the streets and buildings in Menlo Park with 1000 lights. The continuous and stable power supply has become the most important infrastructure service of the entire industrial economy since then. As the digital economy becomes more prominent, power grids are also facing challenges for transformation towards digitization, network, and intelligence. The transformation and upgrade strategies of the power industry, such as the Energy Internet and ubiquitous electric power IoT, emerge accordingly.

The power grid system mainly comprises five parts: generation, transmission, transformation, distribution, and consumption throughout delivery of electric power. The backbone power communication network is responsible for power generation, transmission, and transformation which has been fully covered with the optical private network in China. The terminal access network is responsible for power distribution and consumption with features of wide-area coverage and ubiquitous access. The deployment of traditional optical private networks is costly and time-consuming, and is unsuitable for special terrains such as bridges and elevated roads. Thus cannot cater for wide-area ubiquitous access and there are still some considerable coverage blind spots that affect services. In addition, mobility scenarios, such as substation robot inspection and UAS-assisted inspection of power lines, place high demands on wireless networks. To address all these issues, a ubiquitous, flexible, economical, and reliable wireless network is urgently required.

Based on the network slicing technology, 5GDN can virtualize a wireless private network to implement higher security isolation and customized resource allocation. Based on the technologies such as 5G MEC and 5G TSN, 5GDN can realize lower latency and more deterministic connections. Thus why 5GDN can effectively supplements the existing electric power communication private network to solve bottleneck and challenges facing wireless communication services such as intelligent power distribution and inspection.

Let's take the differential protection for power distribution as an example. 5GDN's differentiated network capabilities can achieve ultra-low latency, ultra-high precision synchronous timing, and high reliability. The dedicated network for the 5GDN can meet the strict security isolation requirements of the virtual private network of the electric power industry. In addition to this, the DIY-service network capability can be exposed through northbound APIs to allow electric power customers to autonomously perform O&M and management within the specified scope, such as the network slicing KPI visualization and intra-slice user management. Therefore, the 5GDN based differential protection solution for power distribution can provide more efficient and flexible access solutions with high security and isolation in the electric power industry. Compared with traditional optical fibers, it can effectively reduce deployment costs and greatly improve service provisioning efficiency.



## Cases

- ◆ State Grid Corporation of China (SGCC) Jiangsu Electric Power Company, China Telecom Jiangsu, and Huawei completed the industry's first 5G SA specifications based network slicing field test of millisecond-level precise load control service in Nanjing. State Grid Qingdao Power Supply Company, China Telecom Qingdao and Huawei completed China's largest 5G smart grid field test in Qingdao. The test verified the technical feasibility of 5G network slicing in multiple typical smart grid scenarios, such as high-frequency information collection in substations and smart distributed feeder automation.
- ◆ China Southern Power Grid Shenzhen Power Supply Bureau, China Mobile Shenzhen and Huawei completed the industry's first commercial-oriented 5G power slice field test in Shenzhen. In this project, they completed the industry's first 5G differential protection test for power distribution, as well as a slice isolation test for the 5G CN and TN network. Besides that, the industry's first 5G B2B network slicing management platform also be built for the CSG. China Southern Power Grid highly appraises that 5G power slicing can help build a safe, reliable, flexible, dedicated virtual network for power grid services and better meet the power grid service requirements of high isolation and customized security. This network is isolated with high reliability and customized security.



5G is cost-effective, flexible, secure, reliable, and offers DIY-based automatic O&M. Network slicing and 5G MEC can build a virtual wireless private network that fulfills the wide-area access requirements of power grid services, while driving innovation and promoting the development of the Energy Internet. Applying 5G in smart grids provides greater technical support for the phasor measurement unit (PMU), relay protection, and distribution networks etc. We believe that 5G deployment will provide a new communication method for the secure and stable operation of the power grid.

–Liu Jianming, Team Leader of the China D2-5G Working Group of the International Council on Large Electric systems (CIGRE)

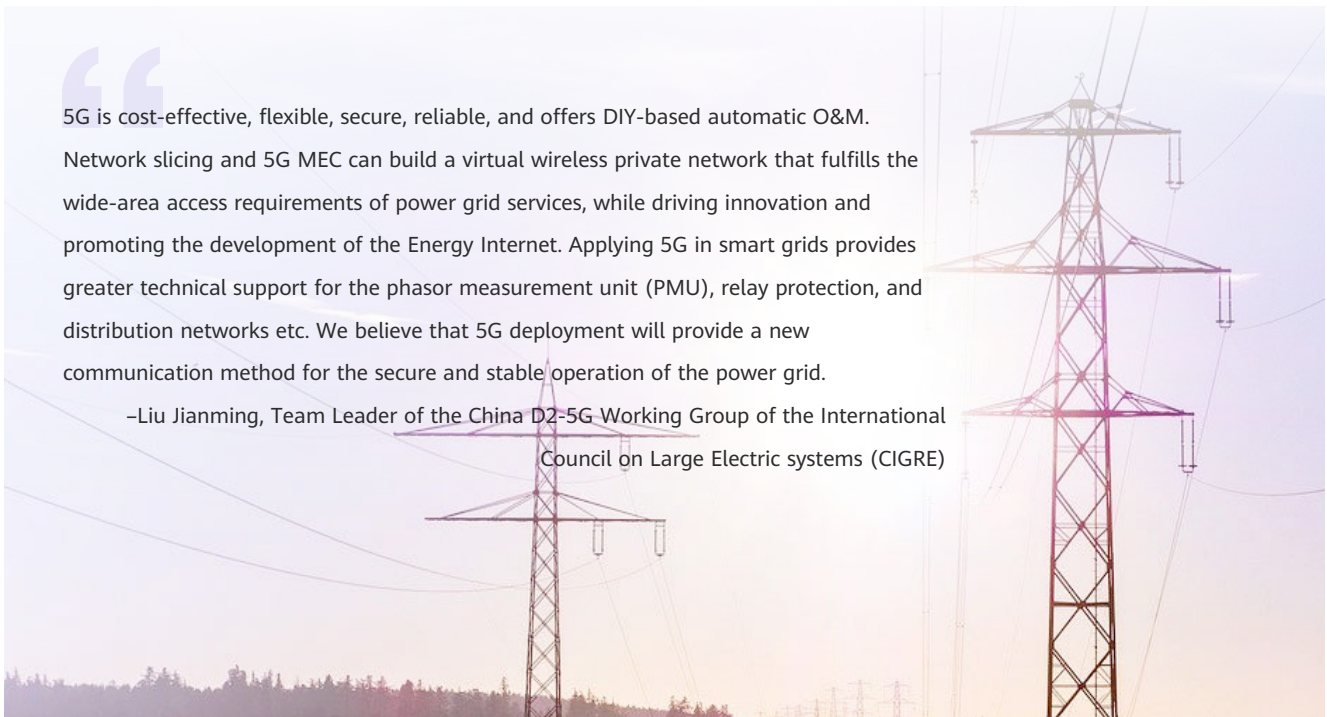

## 3

## 5GDN@Smart Manufacturing

The new wave of technology is transforming global manufacturing into a more intelligent, flexible, service-centric, and high-end industry. Smart manufacturing demands high-performing and flexible wireless networks. 5GDN ensures diversified and high-quality communication for the smart manufacturing system, and promotes the convergence and interaction of massive information in all phases. It is estimated that the market potential of 5G in smart manufacturing will reach US\$232 billion by 2025.

Conventionally, manufacturers mostly rely on wired technology to connect production facilities. At present, fixed lines are still dominant in the industrial internet IIoT. However, compared with wired network, wireless technologies are more suitable for complex manufacturing environments as well as reducing the cost of line upgrades. In recent years, short-range wireless communications technologies such as Wi-Fi and Bluetooth have been applied in manufacturing. Nevertheless, due to its best effort transmission mechanism, and problems such as delay, packet loss, etc., these technologies cannot be used in time sensitive scenarios. And some other problems such as data silos, security risk, etc., also exist. Therefore, the manufacturing industry spontaneously drives the deterministic requirements for wireless networks, which require a series of conditions such as high reliability, low delay and security, so as to promote the commercialization of these industrial scenarios..

Smart manufacturing scenarios include machine vision, AR collaboration, remote control, cloud-based AGV, etc.. For example, machine vision, as a typical scenario in smart manufacturing, requires an uplink bandwidth of more than 50Mbps or even 200 Mbps, an end-to-end communication latency of less than 10 ms, as well as a reliability of over 99.9999%. 5GDN can well fulfill these requirements. Moreover, 5GDN provides machine vision scenarios with LAN networking services and dedicated network services to ensure data security of industrial enterprises. 5GDN also provides self-service network capabilities to implement flexible O&M and agile self-management. Therefore, the 5GDN-based machine vision solution implements cloud-based control, algorithm-based self-optimization, and security assurance for enterprise data processed inside the campus. Furthermore, this solution breaks the bottlenecks of traditional machine vision, such as high costs, low efficiency, and unstable quality, and as such greatly reduces investment costs and significantly improves operation efficiency.

Cases

In July 2019, Haier, together with China Mobile and Huawei, officially released the world's first AI+5G interconnected factory at the Industrial Internet Ecosystem Innovation Forum of 2019 World Industrial Internet Conference (WIIC) held in Qingdao. By leveraging key technologies such as cloud native, dynamic intelligent network slicing, and heterogeneous ultra-performance MEC, the 5GDN provides differentiated and deterministic network service capabilities. It constructs an intelligent manufacturing system for complex scenarios, such as 5GDN+smart devices, 5GDN+machine vision, and 5GDN+AR man-machine collaboration to implement flexible and efficient mass customization production. In addition, the 5GDN enables digital operations of production data, empowering managers to gain real-time and accurate insights into the production process and product running status comprehensively from more dimensional perspectives. Besides, AI+5G technologies are applied in depth throughout the phases of user interaction and product R&D, enhancing self-awareness of the whole process information and achieving more accurate supply-demand matching.

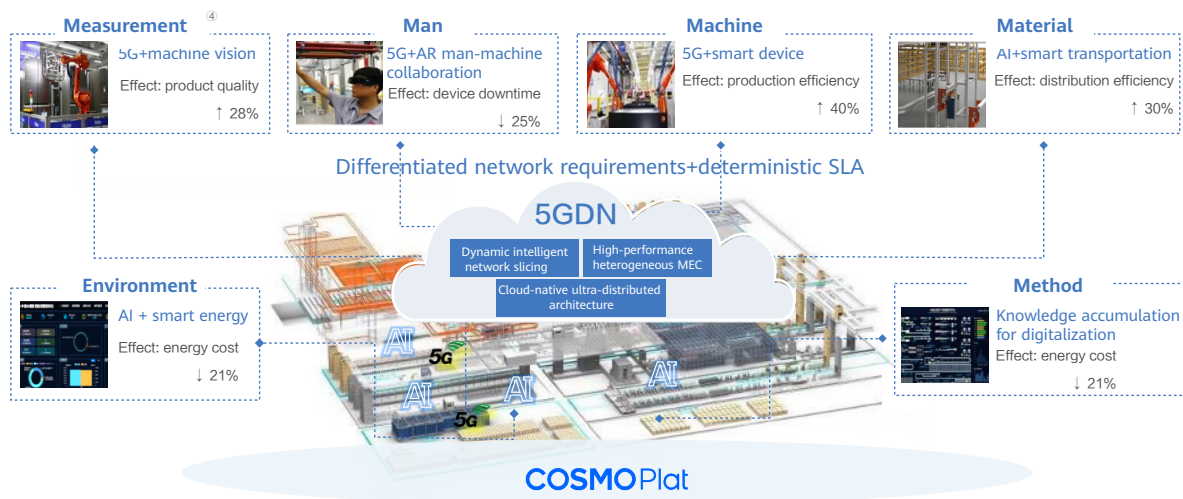

Figure 13 - World's first 5G+smart interconnected factory

Based on the intelligent implementation of 5GDN, Haier's industrial park realized the migration of cloud-based algorithms and the security guarantee of data being processed locally within the park. As a result, the challenges of efficiency, security, and labor costs encountered in traditional factories are tackled, and the requirements of intelligent operation in the factories are satisfied. It is shown by practice that the product quality is improved by 28%, the device downtime is reduced by 25%, the production efficiency is improved by 40%, and the investment is saved by 30%.

Haier pays special attention to the important role of 5G in the transformation and upgrade of smart manufacturing. Based on the COSMOPlat industrial Internet platform, that is combined with the characteristics of high bandwidth, low latency, dedicated secure network, and flexible O&M provided by 5G deterministic networking, the Haier interconnected factories effectively improve production management efficiency, reduce costs, and improve quality. This enables the realization of “user experience centric” mass customization and continuous satisfaction of users’ better life.

–Zhang Weijie, Executive Director of Haier Institute of Industrial Intelligence



## 4

### 5GDN@AR/VR

The development of AR/VR technologies has reshaped many industry markets, including gaming, video livestreaming, education and training, and outdoor advertisements. 5G, as a basic platform technology, combines with AR/VR technology to promote development of various AR/VR applications. It is estimated that 5G-enabled AR/VR industry market space will reach US\$137 billion by 2025.

The development of lightweight AR/VR terminals, and high-frequency rendering and more intelligent factors of AR/VR applications require AR/VR computing capability to be moved upward. In addition, the immersive experience of AR/VR applications requires low latency (less than 20 ms ensures optimal experience) and high bandwidth (5G streaming media requires a bandwidth of higher than 100 Mbit/s). However, traditional wired networks face challenges such as complex networking, long deployment period, unstable Wi-Fi connections, poor mobility, and high latency of cloud-based AR interaction. Therefore, 5GDN will be a key solution to meet market requirements in future AR/VR applications.

Panoramic VR video livestreaming includes video collection, video stitching, projection, encoding, distribution, and decoding. 5GDN uses a dedicated slice for VR video livestreaming where the VR video collection end uploads multiple channels of images to MEC nodes to splice these images into a panoramic image, and then projects, encodes, and distributes the panoramic image. Subscribers can enjoy an immersive experience using lightweight terminals. 5GDN-based VR livestreaming has been successfully applied in activities such as the CCTV New Year’s Gala, MIGU concert, CBA final, and Chongqing International Marathon.

Real-time requirements and location identification are critical in AR interactive applications. Scenes are shot with cameras and uploaded to the nearby MEC node for image recognition. Corresponding content is then selected in real time and superimposed on the real scene, delivering immersive AR experience. This application can be widely used in AR education, cultural tourism, outdoor advertising and other industries. The solution has been applied to smart advertising screens in Shenzhen Airport, large-scale AR interactive 5G+cultural tourism, and AR collaboration in the Haier smart factory.

### Cases

- ◆ CAS-Visual-Dimension and Huawei carried out the AR interactive project - Wonderland of Mountains and Rivers at the Beijing Expo 2019 at a campus with more than 6000 square meters, receiving more than 1000 visitors per day on average. Based on 5G MEC, this project fully leverages ultra-high bandwidth, ultra-low latency, and mobility of 5GDN.
- ◆ Huawei, China Mobile (Shenzhen Guangdong), and Blaz demonstrated the 5GDN+AR cultural tourism at Shenzhen Airport for the first time in December 2019. 5GDN's low latency ensures the user experience of AR advertising applications. Precise positioning enables AR advertisement applications to be precisely launched based on subscriber locations. 5GDN helps outdoor advertising screens in Shenzhen Airport transform from the traditional all-in-one offline mode to the agile online operation mode.



“

Wonderland of Mountains and Rivers, as the brand of CAS-Visual-Dimension, uses Huawei's 5G MEC solution to improve the immersive visual and interactive experience of tourists while reducing the project delivery period by more than 30%.

—Ge Shuiying, Chairman of CAS-Visual-Dimension

“

5G MEC solution provides high bandwidth, low latency, flexible connection, and computing services for AR applications. This greatly simplifies the deployment of AR terminals and delivers a top-quality AR experience for users. 5GDN-based AR advertisement fully reflects a new development trend that integrates advertising, education, and entertainment, delivering richer content and improved O&M efficiency and accuracy of advertising placement.

—Zhu Wenzhen, Founder and Chairman of Blaz



# Summary

5G brings unprecedented changes and opportunities to the telecom industry. By seizing this technology, telecom operators can finally break their growth bottlenecks. The powerful connectivity brought by 5G improves industry's efficiency and competitiveness. 5GDN help operators maximize the value of network connections and drives digital transformation in the industry. 5GDN bridges telecom operators and the industry market. Technically, the 3GPP has defined the basic framework of 5GDN and functions related to deterministic capabilities. These functions will be further developed along with 3GPP R17. All parties need to further explore and gradually promote the "CORE" concept in actual deployment to form a differentiated, dedicated, and DIY 5GDN.



# Acronyms and Abbreviations

Abbreviation	Full Name
2B	To Business
2C	To Consumer
5GDN	5G Deterministic Networking
5GS	5G System
AGV	Automated Guided Vehicle
AI	Artificial Intelligence
API	Application Programming Interface
AR	Augmented Reality
CN	Core Network
DIY	Do It Yourself
eMBB	Enhanced Mobile Broadband
FWA	Fixed Wireless Access
HA	Host Aggregation
IaaS	Infrastructure as a Service
ICT	Information and Communication Technology
IGV	Intelligent Guided Vehicle
IIoT	Industry Internet of Things
LAN	Local Access Network
LTE	Long Term Evolution
MBB	Mobile Broad-Band
MEC	Multi-access Edge Computing
mMTC	Massive Machine Type Communication
NSMF	Network Slice Management Function
NSSMF	Network Slice Subnet Management Function
PMU	Phasor Measurement Unit
QoS	Quality of Service
RAN	Radio Access Network
SA	Stand Alone
SLA	Service Level Agreement
TN	Transport Network
TSN	Time Sensitive Network
uRLLC	Ultra Reliable Low Latency Communication
VDC	Virtual Data Center
VPC	Virtual Private Cloud
VR	Virtual Reality

# Major Contributor



Founded in 2009, the 5G Deterministic Networking Alliance (5GDNA) is an industry alliance jointly initiated by Huawei, China Mobile, China Telecom, China Unicom, China-Japan Friendship Hospital, and other organizations in industries including multimedia, energy Internet, industrial Internet, healthcare, and IoT. Its establishment is aimed at promoting and building 5GDN, creating win-win partnerships, driving business closure, and enabling and accelerating 5G development. 5GDN leverages 5G network resources to build predictable, plannable, verifiable, and deterministic private mobile networks, delivering differentiated service experience.

[http://www.5gdna.org/?\\_l=en](http://www.5gdna.org/?_l=en).



Founded in 1987, Huawei is a leading global provider of information and communications technology (ICT) infrastructure and smart devices. We are committed to bringing digital to every person, home and organization for a fully connected, intelligent world. Huawei has 194000 employees, and operates in more than 170 countries and regions around the world, serving more than three billion people. Huawei's end-to-end portfolio of products, solutions and services in the communications network, IT, smart device, and cloud service sectors are both competitive and secure. Through open collaboration with ecosystem partners, Huawei creates lasting value for our customers, working to empower people, enrich home life, and inspire innovation in organizations of all shapes and sizes.



Founded in 1957, the China Academy of Information and Communications Technology (CAICT) is a scientific research institute directly under the Ministry of Industry and Information Technology (MIIT) of China. CAICT cherishes the cultural philosophy of "boosting prosperity with virtues and expertise", and has been doing so for years while also adhering to its development position: "a specialized think-tank for the government and an innovation and development platform for the industry". CAICT is committed to being "the think-tank and enabler for innovation and development in an information society". CAICT has provided strong support for major strategies, plans, policies, standards, tests and certification for the development of the national ICT sector and IT application, proving itself an important facilitator in the profound development and innovation of China's information and communications sector.



Founded in 2000, China Mobile Communications Corporation (CMCC) is the largest telecom operator in the world with the largest network, the most customers, leading profitability and brand value, and top market value. It has a registered capital of CNY300 billion, assets equaling nearly CNY1.7 trillion, and nearly 500000 employees in total. CMCC has been listed in Fortune Global 500 for 18 consecutive years, ranking 53rd in 2018. It has been rated A in performance assessment by the State-owned Assets Supervision and Administration Commission (SASAC) for 14 consecutive years.



Founded in 2002, China Telecommunications Corporation is a very large state-owned telecommunications enterprise in China, which has been listed in the Fortune Global 500 for several years. The main business scope of China Telecom is comprehensive information services such as fixed telephone, mobile communication, and Internet access and applications. By the end of 2008, China Telecom owns over 214 million fixed telephone subscribers, 35.44 million mobile phone subscribers, and 47.18 million broadband subscribers. All of China Telecom's assets exceed CNY632.2 billion in worth, with an annual revenue of more than CNY220 billion. It has 670,000 employees.



China United Network Communications Group Co. Ltd. (China Unicom), established in 2009, is the only Chinese telecom operator listed in the stock exchanges of New York, Hong Kong and Shanghai. It has subsidiaries in 31 provinces (autonomous regions and municipalities) across China and many countries and regions around the world. It has been selected as a Fortune Global 500 enterprise for 10 consecutive years, and ranked 273rd in the Fortune Global 500 list in 2018. China Unicom operates fixed and mobile communication services, domestic and international communications facilities, data communications, network access services, value-added services, and system integration services.



**Huawei Technologies Co., Ltd.**

Huawei Industrial Base  
Bantian, Longgang  
Shenzhen 518129

<https://www.huawei.com>

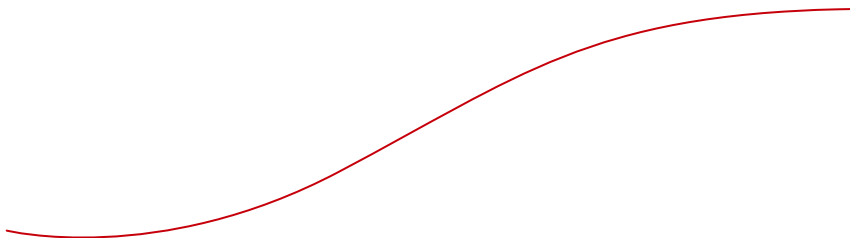

**Copyright © Huawei Technologies Co., Ltd. 2019. All rights reserved.**

No part of this document may be reproduced or transmitted in any form or by any means without prior written consent of Huawei Technologies Co., Ltd.

#### **Trademarks and Permissions**



and other Huawei trademarks are trademarks of Huawei Technologies Co., Ltd.

All other trademarks and trade names mentioned in this document are the property of their respective holders.

#### **Notice**

The purchased products, services and features are stipulated by the contract made between Huawei and the customer. All or part of the products, services and features described in this document may not be within the purchase scope or the usage scope. Unless otherwise specified in the contract, all statements, information, and recommendations in this document are provided "AS IS" without warranties, guarantees or representations of any kind, either express or implied.

The information in this document is subject to change without notice. Every effort has been made in the preparation of this document to ensure accuracy of the contents, but all statements, information, and recommendations in this document do not constitute a warranty of any kind, express or implied.